

GEMTOR™

... when your life is on the line™

USER INSTRUCTIONS

5K ZINC PLATED SWIVEL ANCHOR

Complies with ANSI Z359.18 Type A,
OSHA 29 CFR 1910 and 1926 regulations.

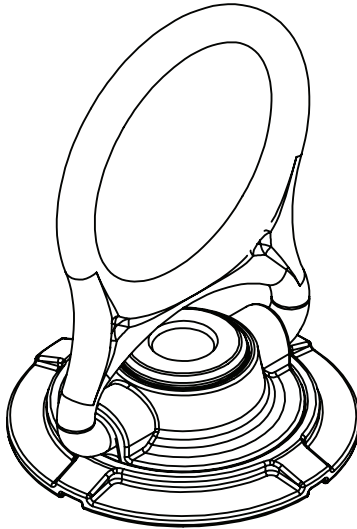

OPERATION AND INSTRUCTION MANUAL

Swivel Anchor

Models: DAS-5K, DAS-5KC



WARNING: ALL USERS OF THIS EQUIPMENT MUST READ AND UNDERSTAND ALL INSTRUCTIONS. FAILURE TO DO SO MAY RESULT IN SERIOUS INJURY OR DEATH. USERS SHOULD BE FAMILIAR WITH PERTINENT REGULATIONS GOVERNING THIS EQUIPMENT. ALL USERS OF THIS PRODUCT MUST BE PROPERLY INSTRUCTED ON HOW TO USE THE DEVICE. AVOID CONTACT WITH PHYSICAL HAZARDS (THERMAL, CHEMICAL, ELECTRICAL, ETC.). MAKE ONLY COMPATIBLE CONNECTIONS.

Read This Instruction Manual Carefully Before Using This Equipment.

User Instructions must always be available to the user and are not to be removed except by the user of this equipment. For proper use, see supervisor, User Instructions, or contact the manufacturer.



Compliant fall arrest and emergency rescue systems help prevent serious injury during fall arrest. Users and purchasers of this equipment must read and understand the User Instructions provided for correct use and care of this product. All users of this equipment must understand the instructions, operation, limitations and consequences of improper use of this equipment and be properly trained prior to use per OSHA 29 CFR 1910.30 and 1926.503 or applicable local standards. The local competent person must keep these instructions, make them available to users, and require their use.

Misuse or failure to follow warnings and instructions may result in serious personal injury or death.

PURPOSE

The DAS-5K & DAS-5KC are anchorage connectors designed to function as an interface between the anchorage and a fall arrest, work positioning, rope access, or rescue system for the purpose of coupling the system to the anchorage. Any references to "anchorage connector" in this manual include, and apply to the DAS-5K & DAS-5KC.

USE INSTRUCTIONS

1. A user must be of sound mind and body to properly and safely use this equipment in normal and emergency situations.
2. Before using a personal fall arrest system, user must be trained in accordance with the requirements of OSHA 29 CFR 1910.30 and 1926.503 in the safe use of the system and its components.
3. Use only with ANSI/OSHA compliant personal fall arrest or restraint systems. The anchorage must have the strength capable of supporting a static load, applied in the directions permitted by the system, of at least 5,000-lbf (22kN) in the absence of certification.
4. The user must be equipped with a means of limiting the maximum dynamic forces exerted on the user during the arrest of a fall to a maximum of 1800-lbf (8 kN).
5. Use of this product must be approved by an engineer or other qualified person to be compatible with any and all structural & operational characteristics of the selected installation location and system to be connected to this anchorage connector.
6. The anchorage connector must be inspected prior to each use for wear, damage, and other deterioration. If defective components are found, the anchorage connector must be immediately removed from service in accordance with the requirements of OSHA 29 CFR 1910.140 and 1926.502.
7. The anchorage connector should be positioned in such a way that minimizes the potential for falls and the potential fall distance during use. The complete fall arrest system must be planned (including all components, calculating fall clearance, and swing fall) before using.
8. A rescue plan, and the means at hand to implement it, must be in place that provides the prompt rescue of users in the event of a fall, or assures that users are able to rescue themselves.
9. After a fall occurs, the anchorage connector must be removed from service and destroyed immediately.

USE LIMITATIONS: This anchorage connector has been tested in compliance with the requirements of ANSI/ASSE Z359.7. Compliance testing covers only the hardware and does not extend to the anchorage and substrate to which the anchorage connector is attached. The anchorage connector must not be used outside its limitations, or for any purpose other than that for which it is intended. If this anchorage connector is used differently from these instructions it must be designed, installed, and used under the supervision of an engineer according to ANSI Z359.6 and local building codes as applicable.

1. The anchorage connector is designed for single user.
2. The anchorage connector may only be loaded in acceptable directions shown under LOADING CONDITIONS DIAGRAM.
3. The anchorage connector is designed to be used in temperatures ranging from -40°F to +130°F (-40°C to +54°C).
4. Do not expose the anchorage connector to chemicals or harsh solutions which may have a harmful effect.
5. Do not alter or modify this product in any way.
6. Caution must be taken when using any component of a fall arrest, work positioning, rope access, or rescue system near moving machinery, electrical hazards, sharp edges, or abrasive surfaces, as contact may cause equipment failure, personal injury, or death.
7. Do not use/install equipment without proper training by a "competent person" as defined by OSHA 29 CFR 1926.32(f).
8. Do not remove the labeling from this product.
9. Additional requirements and limitations may apply depending on anchorage type and fastening option utilized for installation. All placements must be approved by an engineer or other qualified person
10. This anchorage connector should not be used as part of a horizontal lifeline system that has not been designed and/or approved to be used with 5,000-lbf (22kN) anchorage connectors.
11. The anchorage connector should only be used for personal fall arrest and not for lifting equipment.
12. If attaching the anchorage connector to the support structure by methods other than instructed, the attachment must be certified by a qualified person to meet the requirements of the system that will connect to the anchorage connector.

COMPATIBILITY LIMITATIONS

Anchorage connectors must only be coupled to compatible connectors. OSHA 29 CFR 1926.502 and 1910.140 prohibits snaphooks from being engaged to certain objects unless two requirements are met: it must be a locking type snaphook, and it must be "designed for" making such a connection. "Designed for" means that the manufacturer of the snaphook specifically designed the snaphook to be used to connect to the equipment listed. The following connections must be avoided, because they can result in rollout* when a nonlocking snaphook is used:

- Direct connection of a snaphook to horizontal lifeline.
- Two (or more) snaphooks connected to one D-ring.
- Two snaphooks connected to each other.
- A snaphook connected back on its integral lanyard.
- A snaphook connected to a webbing loop or webbing lanyard.
- Improper dimensions of the D-ring, rebar, or other connection point in relation to the snaphook dimensions that would allow the snaphook keeper to be depressed by a turning motion of the snaphook.

***Rollout: A process by which a snaphook or carabiner unintentionally disengages from another connector or object to which it is coupled. (ANSI Z359.0-2007)**

LABEL LOCATIONS

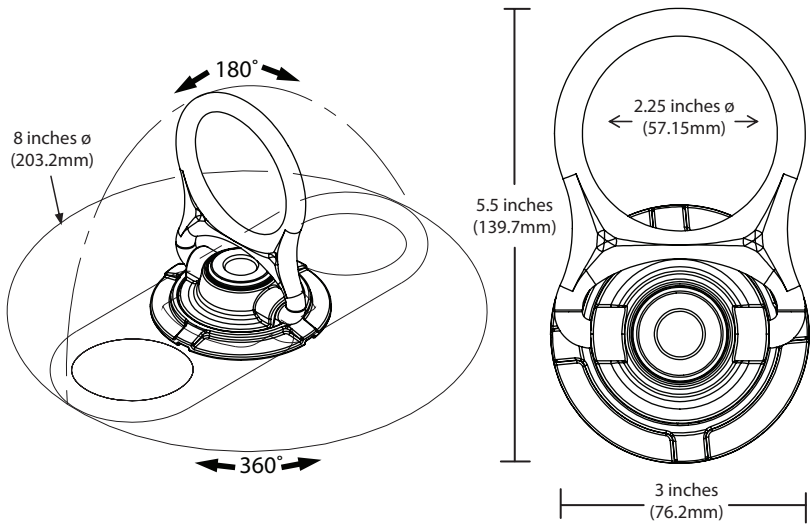
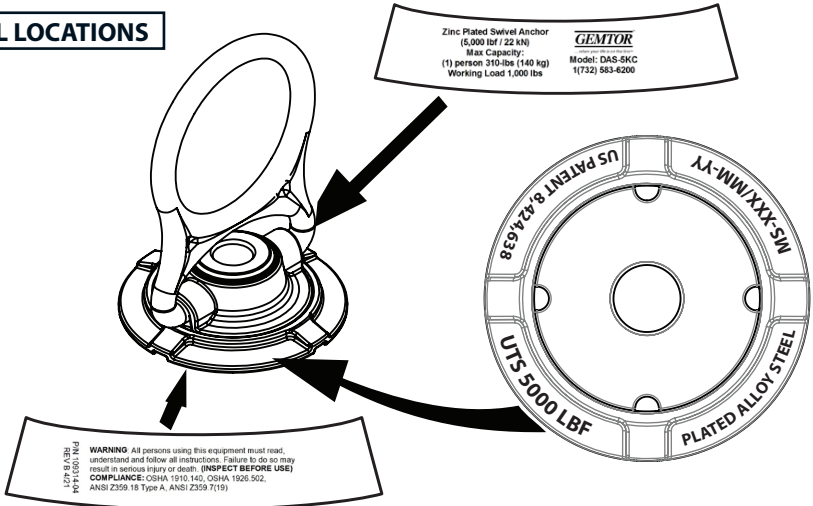

Tensile Strength (UTS): 5,000-lbf (22kN)

Weight: 1.2-lbs (544.3g)

Materials: Zinc Plated Steel

Regulatory Compliance: Meets or exceeds ANSI Z359.18 Type A, ANSI Z359.7-2019 OSHA 29 CFR 1926.502, OSHA 29 CFR 1910.140

LOADING CONDITIONS DIAGRAM

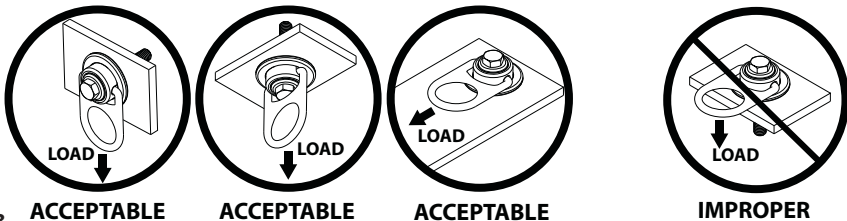

CONCRETE MOUNTING

MODEL: DAS-5K

- Use a proper drill & bit for concrete. (SDS drill bit)
- Drill a .5 inch (13mm) hole no less than 4.5 inches (114mm) deep and 8 inches (203mm) away from any edge.
- Hole must be straight and perpendicular to surface.
- Hole must be free of debris.
- Concrete strength must be at least 3000psi (20.7MPa) and no less than 7 inches (178mm) thick.

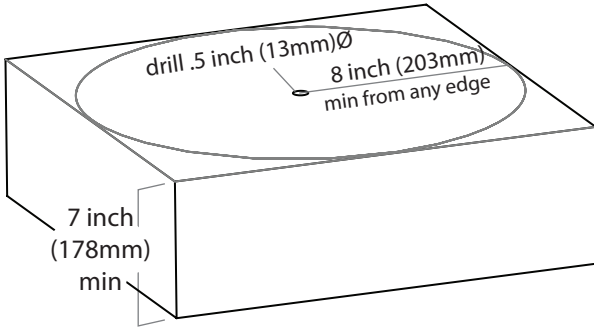

Torque Range:

40 ft-lbs
(54Nm)

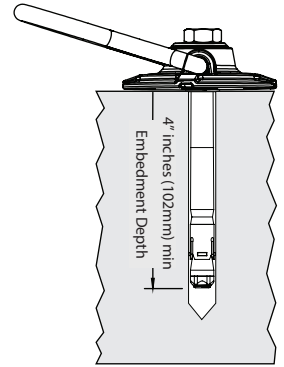

STEEL MOUNTING

MODEL: DAS-5K

.5 inch -13 inch Lock Nut



.5 inch
Lock Washer



.5 inch -13 x 4 inches
Hex Bolt *

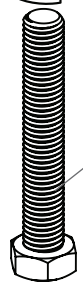

Torque :
45 ft-lbs
(61 Nm)

Use
tapered
washer

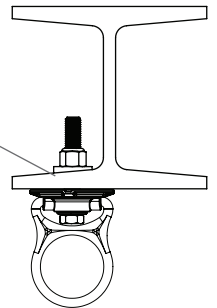

.25 inch
(6mm)
min

drill .5 inch (13mm) Ø

3 inches (76mm)
min from any edge

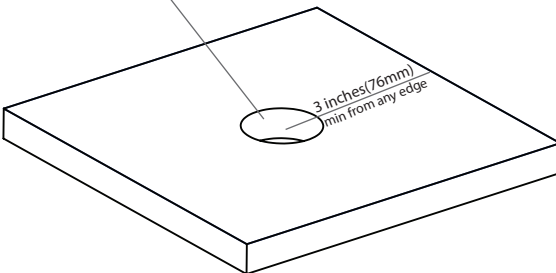

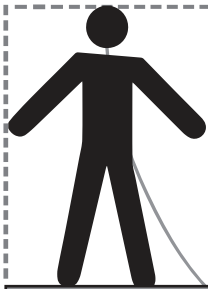

WORK SURFACE

*The user shall be equipped with a means of limiting the maximum dynamic forces exerted on the user during the arrest of a fall to a maximum of 1800-lbf (8 kN).



(ANCHOR POINT)

*The structure the anchorage is attached to must be able to support 5,000-lbf (22kN) and installed under the supervision of a qualified person.



WORK SURFACE

****All products subjected to fall arresting forces should be removed from service immediately!***

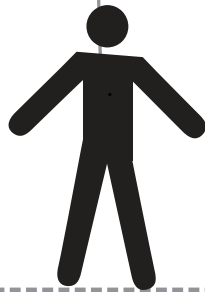

MINIMUM CLEARANCE 2 feet (.6m)

DECK/FLOOR/GROUND LEVEL

WARNING!!! SWING FALLS MAY OCCUR WHEN THE WORKER IS NOT DIRECTLY UNDER ANCHOR POINT.

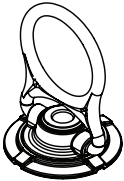
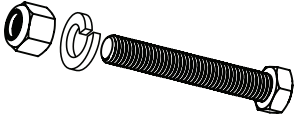
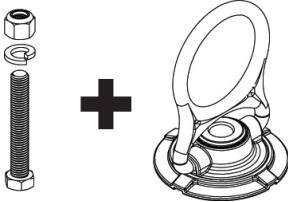
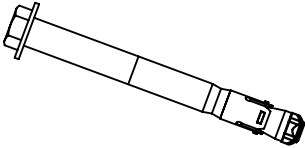
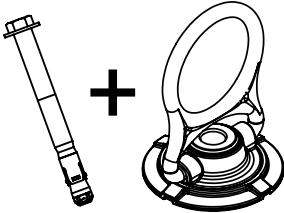

	KIT CONTENTS	PART NUMBER
		DAS-5K (Anchor Swivel 5K)
METAL		DAS-5KS-KIT (Steel Mounting Hardware Kit)
		DAS-5KS (Swivel with Steel Mounting kit)
CONCRETE		DAS-5KC-KIT (Concrete Hardware Kit)
		DAS-5KC (Swivel with Concrete Mounting Kit)

For more information:



MAINTENANCE, CLEANING AND STORAGE

Cleaning periodically will prolong the life and proper functioning of the product. The frequency of cleaning should be determined by inspection and by severity of the environment. Clean with compressed air and/or a stiff brush using plain water or a mild soap and water solution. Do not use any corrosive chemicals that could damage the product. Wipe all surfaces with a clean, dry cloth and hang to dry, or use compressed air. When not in use, store anchorage connectors in a cool, dry, clean environment, out of direct sunlight and free of corrosive or other degrading elements.

INSPECTION AND MAINTENANCE LOG

MODEL NUMBER: _____

DATE OF MANUFACTURE: _____

Date	Part Number	Comments	Inspector Name

Inspection:

Official periodic inspection must be made at least annually. The inspection must be performed by a qualified person other than the intended user. If severe environmental conditions exist then inspections must be carried out more frequently. All inspection results must be logged in the space provided above.

- 1. Inspect Swivel to make sure it is flush with mounting surface.
- 2. Ensure all labeling is affixed to the unit.
- 3. Ensure the unit can rotate 360° and D-ring can flip from side to side.
- 4. When reusing a previously drilled hole, inspect for debris or wallowing.
- 5. Record inspection results in the space provided above.

***If inspection reveals any damage that could affect the strength or operation of the device, inadequate maintenance, or an unsafe condition, proper disposal is required. The anchorage connector must be rendered unusable and then properly discarded.**

Gemtor, Inc.
One Johnson Ave
Matawan, NJ 07747
732-583-6200
800-405-9048 (toll-free)
732-290-9391 (fax)
sales.info@gemtor.com
www.gemtor.com